

Waste Elimination in the Assembly Process using Lean Tools

Peter Szabó¹, Samuel Janík¹, Miroslava Mlkva¹, György Czifra²

¹ Faculty of Materials Science and Technology in Trnava, Slovak University of Technology in Bratislava, ul. J. Bottu č. 2781/ 25, 917 24 Trnava, Slovak Republic, E-mail: peter.szabo@stuba.sk, samuel.janik@stuba.sk, miroslava.mlkva@stuba.sk

² Óbuda University, Bánki Donát Faculty of Mechanical and Safety Engineering Népszínház u. 8, 1081 Budapest, E-mail: czifra.gyorgy@bkgk.uni-obuda.hu

Abstract: A highly dynamic competitive environment leads industrial companies to constantly re-evaluate their processes and strategies. Globalization, strong competition, as well as ever-evolving trends are putting pressure on businesses to increase their flexibility to respond immediately to these trends and to develop the ability to produce products based on consumer demands. Continued efforts for greater flexibility are supported by the Lean concept, which is considered one of the most efficient production concepts. Lean methods are a recognized traditional approach to eliminating waste and streamlining production processes. In recent years, a new Industry 4.0 paradigm has been defined. As a counterpoint to the usual methods, it brings new technological approaches. By integrating these two philosophies, it is possible to achieve strategic goals, reduce costs, increase competition, etc. The aim of the paper is to point out the possibilities of applying lean tools to eliminate waste in the assembly process. With the help of lean tools, the identified shortcomings and waste are eliminated, bottlenecks and inefficient flows in the production process are identified. In this paper, we point out the importance and need for the application of lean methods in industrial enterprises, in order to identify the causes of unnecessary waste of resources (e.g. material, human resources, financial resources, etc.).

Keywords: Assembly; Waste Elimination; Lean Tools; Values Stream Mapping

1 Introduction

In recent years, a new paradigm of Industry 4.0 has been defined, the so-called fourth industrial revolution with the potential to take production processes to the next level [1]. Industry 4.0, as a counterpoint to the usual methods, brings new technological approaches for companies. By integrating these two philosophies, especially into manufacturing companies, it is possible to achieve strategic goals,

reduce costs and increase competitiveness [2]. One of all possibilities is the lean manufacturing strategy. Lean manufacturing aims to reduce costs by removing value-added activities. Based on the Toyota manufacturing system, many lean manufacturing tools (e.g. Just in Time, Value Stream Mapping – VSM, etc.) are widely used in industrial manufacturing, including the automotive industry [3].

Industry 4.0 is characterized by a "blending of technology that blurs the boundaries between digital, physical and biological spheres" Industry 4.0 marks a shift in the manufacturing industry for digitization and decentralization of premises from production halls to office spaces and across enterprise networks [4]. The digital transformation of manufacturing is also affected by such trends as IoT, Industry 4.0, data and analytics, artificial intelligence and machine learning [5]. It also enables the creation of a smart network of machines, products, components, properties and systems throughout the value chain, thus forming a smart factory. Both of these approaches aim to increase productivity and flexibility [1]. Industry 5.0 is a new concept that focuses on collaborative collaboration between humans and machines. The goal is to create sustainable products and services [6].

2 Theoretical Review – Lean Tools and Waste Elimination

Lean manufacturing is currently a manufacturing paradigm. The goal of lean manufacturing is to improve/optimize production processes in various areas, including reducing production costs [7], improving the quality of production processes [8], improving/shortening delivery times [8, 9], increasing flexibility [10], avoiding waste in processes [11], etc. Lean manufacturing emphasises visual control and transparency, which makes it easier to identify problems in the process [12].

The paper focuses on the elimination of waste in the production process by identifying unnecessary activities, streamlining the process using lean tools and techniques in accordance with the requirements of Industry 4.0.

2.1 Waste – Characteristics, Types of Waste

Waste (loss) is any activity (process, cost) that is performed in the production of products or in the implementation of a service, and which does not add value to the product and increases its costs [13]. Wastage is very wide and can occur in a variety of activities. Seven main types of waste are most frequently mentioned in the literature, under the acronym TIMWOOD [14]. A more detailed description of each type of waste can be found in Table 1.

Table 1
Description of individual types of waste [based on: 15, 16, 17]

| Types of waste | Description |
|-----------------------|--|
| <i>Transportation</i> | It includes any movement of materials that does not add any value to the product. Transportation between processing stage results in prolonging production cycle times, the inefficient use of labour and space. |
| <i>Inventory</i> | It means having unnecessarily high levels of raw materials, works-in-process and finished products. Extra inventory leads to higher inventory financing costs, higher storage costs and higher defect rates. |
| <i>Motion</i> | It includes any unnecessary physical motions or walking by workers which divert them from actual processing work. This might include walking around the factory floor to look for a tool, or even unnecessary or difficult physical movements, due to poorly designed ergonomics, which slow down the workers. |
| <i>Waiting</i> | It is idle time for workers or machines due to bottlenecks or inefficient production flow on the factory floor. It includes small delays between processing of units. This waste occurs whenever goods are not moving or being worked on. |
| <i>Overproduction</i> | It is unnecessary to produce more than the customer demands, or producing it too early before it is needed. This increases the risk of obsolescence and the risk of producing the wrong thing. |
| <i>Overprocessing</i> | It is unintentionally doing more processing work than the customer requires in terms of product quality or features such as polishing or applying finishing in some areas of product that will not be seen by the customer. |
| <i>Defects</i> | In addition to physical defects which directly add to the costs of goods sold, this may include late delivery, production according to incorrect specifications, use of too much raw materials or generation of unnecessary scrap. |

In addition to these types of waste, waste also includes untapped human potential. This waste occurs when organizations separate the role of management from employees [18]. It follows from the above that the cause of waste can be, e.g. clutter, insufficient communication, poor planning, etc. This problem can be avoided by using various tools and methods such as VSM, Spaghetti diagram, or process analysis.

2.2 Selected Lean Methods

Lean manufacturing methods are a widely accepted traditional approach to eliminating waste and streamlining production processes [2]. The methods that have been selected for the purposes of research and publication form an active part of the everyday life of the researched industrial enterprises (see the sample of research). Industry 4.0, as a counterpoint to the usual methods, brings new technological approaches for companies. To realize the full potential of Industry

4.0, companies need to understand new technologies and their opportunities. To take advantage of all the opportunities offered by Industry 4.0, it is essential that the various systems are fully integrated with each other, otherwise it is possible that only 40-60% of their potential value will be captured [19]. Preliminary research shows that Industry 4.0 technologies can be integrated into selected lean manufacturing methods in order to make them more efficient.

2.2.1 Spaghetti Diagram

Spaghetti diagrams are Lean tools that can be used to identify wasted motion. A Spaghetti diagram is a visual tool that shows the physical movement of a “work object” such as a product, an employee or document, through the processes in a value stream [20]. Fig. 1 shows an example of Spaghetti diagram. Lean Enterprise Institute defines Spaghetti diagram as diagram of the path taken by a product as it travels through the steps along a value stream. So-called because in a mass production organization the product’s route often looks like a plate of spaghetti [21].



Figure 1
Example of Spaghetti diagram [21]

This type of diagram allows to use different colours for various products, workers or technical means and track the movement at different times. After the analysis we can identify the movement lengths, number of movements, overlapping and crossing movements and their characteristics according to the chosen classification [22]. It is a quick and easy way to track distances of parts and people on the shop floor. Please note that the spaghetti diagram is, by itself, not an optimization method. It only gives you the current state data of the distances [23]. Applying the result of the Spaghetti diagram, we can identify inefficient movements and ineffective areas, eliminate the number of staff, and make changes in the work organisation or workstation layout [22].

2.2.2 VSM – Value Stream Mapping

Value Stream Mapping (VSM) or Value Stream Analysis is an analytical technique that is one of the basic methods of lean manufacturing philosophy. Based on Abdulmalek and Rajgopal [24] this map is used to identify sources of waste and to identify lean tools for reducing the waste. Value stream mapping is a Lean management method that allows you to visualize, analyze and improve all the steps in a product delivery process. A value stream map displays all the important steps of your work process necessary to deliver value from start to finish. It allows you to visualize every task that your team works on and provides single glance status reports about each assignment's progress [25].

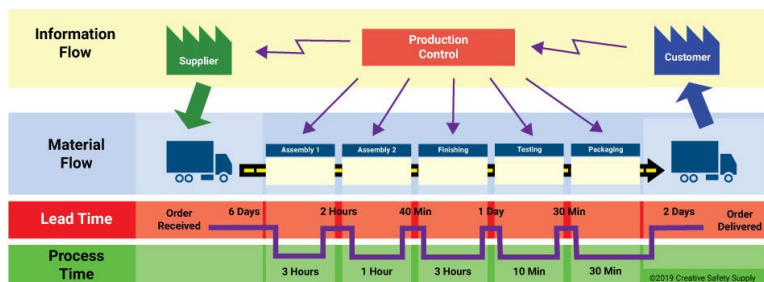

Figure 2
Example of Value Stream Mapping [26]

Value stream mapping is an analytical tool that is considered one of the most effective in optimizing production. It monitors all activities that add and do not add value for the customer. When creating a map of the flow of values, it is essential to state the parameters characterizing the individual processes. These parameters serve as performance indicators, based on which we can determine whether the process is in the desired state [27].

Industry 4.0 leads to an interconnected production environment where it is possible to monitor and share data in real time. By applying Auto-ID technology it is possible to immediately identify an object, with the help of Big Data it is possible to analyze a large amount of data, which facilitates their consolidation [28]. VSM, which constantly receives new data and information from the receipt of the order through the production process to the sending of the order, can effectively guide the entire flow and constantly identify waste. Such intelligent process control lays the foundation for optimizing production processes, thus enabling the flow of values of several possible alternatives to be mapped [2].

VSM, which is based on the support of Industry 4.0 technologies, has better transparency thanks to constant monitoring of the value chain in real-time, which leads to greater flexibility in the decision making process [28].

Value stream mapping helps identify possible instead of losses, bottlenecks, weaknesses and reasons for inefficient flows anywhere in the enterprise [3].

The benefits of value stream mapping are [22]:

- With the help of VSM, you can identify wasteful activities.
- VSM provides a clear view of the work process - where value-adding and non-value-adding stages form. A good practice is also to visualize how long it takes for work items to go through them.
- VSM highlights the current workflow and brings the focus on future improvement.

2.2.3 Yamazumi Chart

To achieve a customer driven value stream it is important to design the production or manufacturing system to be consistent with the pace at which the customer is demanding a part or product. This pace is often referred to as the “Takt time” [3, 27]. Takt time or clock time is the basic indicator of lean manufacturing. *Takt Time* may be defined based on the market demand and the time available for production, that is, it is about the pace of production necessary to answer the demand. It is the result of the ratio of work time available by slot and the number of units for production [29]. Yamazumi chart is a Japanese method designed to visualize the time data of activities identified in the analyzed process. The data is displayed in the form of a bar graph with a color resolution of activities based on their inclusion in the identified categories [3]. According to Semjon & Evin [30], the Yamazumi chart is: *“a folded column graph showing the balance of the load cycle time between several operators on the assembly line. It may be made for one or more assembly line products.”* Sabadka et al, [31] characterizes the Yamazumi chart as a bar chart that shows the total cycle time for each operator when performing their process in the production flow.

3 Data and Research Methodology

In the previous chapters, selected methods of lean manufacturing used in automotive companies operating in the Slovak Republic were presented (since they are multinational corporations with representation in several countries around the world). The presented results are based on research tasks performed in industrial companies belonging to the automotive segment and their supply chains. The survey was conducted on a sample of 13 companies selected at random. The aim of the survey was to determine the level of application of lean methods in order to eliminate waste in the production process in order to increase the efficiency of the investigated processes. The results are shown in Figure 4, the findings were obtained during long-term analysis and cooperation within the frame of cooperation with these companies in research projects.

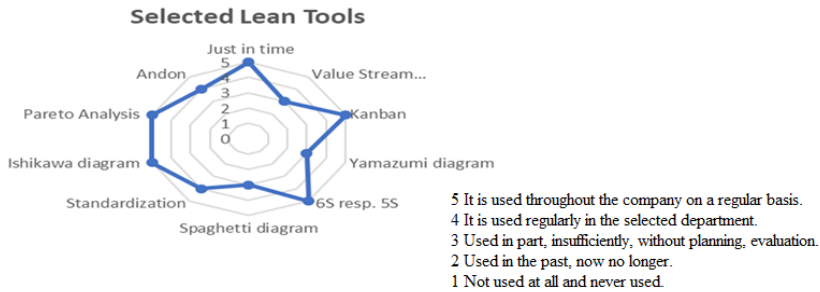

Figure 4

Lean manufacturing methods usage in Automotive (source: own processing based on several surveys)

From the graph (Figure 4) we have shown that methods such as Ishikawa Diagram, Pareto Analysis, JIT, 6S and Kanban are used in the automotive industry sufficiently, which may either be their simplicity of application, or relation to the requirements of standards that are obligatory on the automotive industry. Method Andon and Standardization is used in enterprises, but in some cases only in selected workplaces. The VSM method as well as the Yamazumi and Spaghetti diagrams are poorly utilized in the enterprises surveyed. Based on an extensive review of the existing literature and authors' evaluations, Table 2 shows a matrix to illustrate which I4.0 tools can be used to support the lean methods and tools analyzed. The tools were selected based on a review of academic and corporate publications [28].

Table 2
Lean methods and Industry 4.0 tools linking matrix [based on: 28]

| Lean methods I4.0 tools | JIT / JIS | Kanban | VS M | VM | |
|----------------------------------|-----------|--------|------|-----|-------|
| | | | | 5 S | Andon |
| Human-computer interaction (HCI) | | x | x | x | x |
| Digital object memory | x | | | | |
| Digital twin/simulation | x | x | x | x | |
| Cloud computing | x | | x | | |
| Real-time computing | x | x | x | x | x |
| Big data & data analytics | x | x | x | | |

In the case study, we point out the importance and need for the application of the examined methods in companies, because they make it possible to identify the causes of unnecessary waste of resources. The VSM, Yamazumi chart and Spaghetti chart helps identify losses, bottlenecks and inefficient flows in the production process.

4 Lean Tools Application for Waste Elimination – Company Case Study

This part of the paper will deal with the systematic identification and elimination of waste and inefficiency by the application of selected lean manufacturing methods in the context of Industry 4.0 technologies. In order to meet the requirements of lean manufacturing and to be able to produce efficiently and at the lowest cost, we chose to use lean manufacturing methods in the analysis of the selected assembly process and based on the results of the analysis propose solutions to eliminate waste and streamline the process of assembly. The selected assembly process is characterized as manual, no machines are used in the assembly process. The analysis was performed using the method of predefined times MOST, from which we gathered the necessary data. The collected data were interpreted using the YAMZUMI graph, the lean production methods: VSM, and the spaghetti diagram.

The analysis was executed on the project of the assembly line, which consists of lines A and B. Figure 5 shows a map of the value flow (VSM) of the selected assembly line (B). The VSM map will allow us to identify wastes in the process, monitor VA activities (with added value) and NVA activities (without added value), and identify opportunities for improvement (kaizen). VSM represents the assembly process of line B, which consists of 2 parts (Bx, By), where 2 products are assembled separately, which form the finished product with the product from line A. The complete product, which is created by combining products from lines A and B is paired at the marriage station. In the value stream map, a data box is assigned to each assembly station. This box contains information:

- CT – Cycle Time,
- TT – Takt Time,
- CTT – Company Takt Time,
- Utilization – Operator utilization (%),
- WIP – Work in Progress.

CT represents the time within which it is possible to complete all process steps at the workplace and is calculated using predefined time methods – MOST. TT is a manufacturing term to describe the required product assembly duration that is needed to match the demand, in order to meet customer requirements. The selected assembly line does not work with 100% efficiency, but only with 95%. This (measured) parameter is reflected in the time at which the assembly line must produce. This time is called the Company Takt Time (CTT). The goal of lean manufacturing is to synchronize CT and CTT as much as possible by balancing, greatly reducing the waste caused by waiting. Utilization reflects the percentage utilization of individual operators at the respective assembly stations. WIP records inventory expectations in the process. WIP is the minimum number of materials in stock of process which an employee needs to complete the process without undue waiting. However, the aim is to minimize these stocks so there won't be unnecessary material (waste) in inventory.

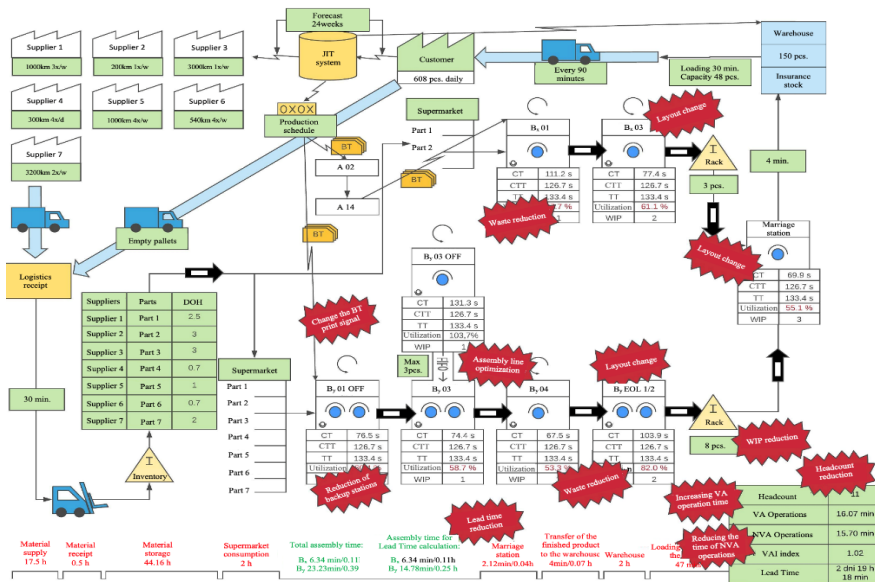

Figure 5

Identified kaizens in the VSM of the current state of the B line

The lower part of the VSM (Figure 5) shows the time axis. The beginning of the timeline contains 4 times - material deliveries, material receipt, material storage, and material consumption in supermarkets. The timeline further contains the assembly times for the B_x and B_y line, individually. The total assembly time of the B_x line is equal to the assembly time used to calculate the total lead time. Operators work at stations either directly on the line (online) or at stations near the assembly line (offline). This line does not contain offline stations and each station is served by only one operator. On B_y, these 2 times are different, since the B_y 03 off station operates in parallel, at the same time as the B_y 03 station. Each station B_y 01 off, B_y 03 and B_y EOL 1/2 is operated by two operators, which we also took into account when calculating the total assembly time. In the calculation, we also took into account the backup stations on the B_y line 03. The timeline also displays:

- CTT time at Marriage station (station where products from line A and B are paired),
- the time required to move the finished set to the warehouse of the finished products,
- the time of holding inventory in the warehouse of finished products (in case of problems in production, these stocks provide time to eliminate errors without endangering deliveries for the customer),
- loading of finished products into the truck for dispatch,
- the time required to transport the finished products to the customer.

At the end of the timeline is a data sheet illustrating:

- total number of operators on the line B - 11 ($B_x - 2$, $B_y - 8$, Marriage 1)
- VA operations (16,07 min.),
- NVA operations (15,70 min.),
- VAI index of operations (1,02),
- Lead Time (2 days 19h 18 min.).

By adding the CT of station Marriage, the stations on both lines B_x , B_y (stations where two operators work are added twice), we obtained the sum value for value-added (VA) processes.

The value for NVA operations is obtained as the difference of the total assembly time with VA operations. NVA is caused by the waste within the processes. The VAI value-added index is obtained with use of the formula: $VAI = \Sigma VA / \Sigma NVA$.

Lead time is the result of adding the times defined on the timeline, except for the assembly time of the B_x line. Since both assembly lines produce the same product reference in parallel, the assembly time of line B_y is used to calculate the Lead Time.

The output of VSM is a graphical representation of the value stream and the main indicator is the value-added index (VAI), which we obtain as a proportion of activities that add value to the customer with those that have no added value for them.

The VSM of line B provided us with a comprehensive view of how the project works from the order, across production to the final shipment. Through VSM, we received a comprehensive analysis of the entire project, and we did not approach the processes individually, but as a set of all processes that are interconnected.

The Yamazumi graf is a visual tool that helps in finding an effective employee cycle in the process. By interpreting the data obtained using the MOST method and their subsequent application to the VSM method for the purpose of a more detailed analysis, we compiled a Yamazumi graph (Figure 6). In addition to VA (value added - green) and NVA (non value added - red) operations, the Yamazumi chart also takes into account BVA (business value added - yellow) operations and untapped potential (waste caused by waiting - gray). Although these operations (BVA) have no value for the customer, they are necessary in the assembly process. The Yamazumi graph clearly shows the current utilization of operators in relation to the takt time and shows in detail the process operations and their distribution with respect to VA, NVA, BVA and untapped potential. The most common waste is the waste caused by scanning, for this reason it is specifically marked in the graph (NVA scanning - pink).

The graph of Figure 6 shows the utilization of operators at individual stations of line B. It is clear from the graph that at several stations the operators are not

utilized effectively, mostly at the station B_y 03, 04 and Marriage station, where there is a waste caused by waiting more than 50 seconds. Significant waste caused by waiting is also at the B_y 01 off station, but these stations are ergonomically very demanding for operators. At the offline station B_y 03 off A / B, the operator is utilized above the Company Takt Time, and therefore there is a risk of slowing down the entire production process of the B line. At present, this anomaly is covered by employees who are best trained and able to work more efficiently than the time result of the MOST analysis. By compiling a value stream map and interpreting the predefined time data using a Yamazumi graph, we were able to identify the wastes that occur in the assembly process on line B.

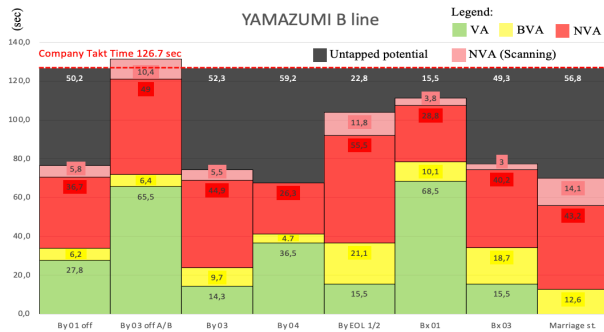

Figure 6
Yamazumi chart showing waste including scanning on the B line

The spaghetti diagram identifies and highlights waste caused by the excessive motion of operators and, compared to VSM, is only created for a specific section of the layout. Organizations tend to ignore the importance of workplace layout and operators movements within the layout. The biggest waste of motion we identified using VSM analysis and Yamazumi graph regarding CTT occurs on the backline at B_x 01, B_x 03, and B_y EOL 1/2. To visually illustrate the waste caused by motion, we created a spaghetti diagram by observing the assembly process and the operators (Figure 7).

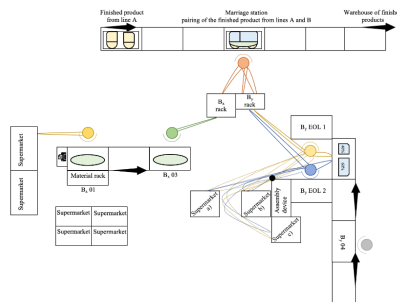

Figure 7
Spaghetti diagram applied on a selected part of the B line layout

5 Results and Discussion

The most frequently identified wastes based on the analysis (waiting, motion, overprocessing, WIP), opportunities for improvement are also marked on the value stream map (Figure 5) using the “Kaizen” symbol. The most significant opportunities to eliminate the identified waste are:

- assembly line optimization, reduction of stocks in the process,
- reduction of waste in assembly processes by optimizing, reducing overprocessing,
- changing the layout of workplaces to reduce waste caused by excessive motion of operators.

After adding up the waste that occurs when scanning on line B, we reached a value of 54,4 seconds. The barcode scanning process itself is not included in this calculation. At present, organizations mostly use a wireless barcode scanner for scanning purposes (see Figure 8). Scanner holders, which also serve as chargers, are located at operators' distances at all assembly stations.



Figure 8
ZEBRA wireless scanner [32]



Figure 9
Gloves MARK 2 standard [33]

The German company ProGlove is a relatively young company that has been present on the European market since September 2016. They strive to improve, streamline work processes with regard to ergonomics through the application of digitization and the fourth industrial revolution (Industry 4.0). The company manufactures and distributes gloves that include a detachable scanner holder. There are several variants of gloves to choose from. The best choice for the selected analyzed assembly process according to the authors of the paper is the variant of gloves "MARK 2 standard" shown in Figure 9.

The advantages of the "MARK 2 STANDARD" gloves include:

- higher safety of operators due to the adhesion of gloves which allows a firmer grip of the material,
- simple process documentation (digitization of collected data from scanning),
- increased efficiency of processes and reduction of errors due to verification of parts,
- elimination of motion waste caused by retrieving and returning the scanner to the holder, improved ergonomic conditions of employees.

By implementing this technology across Line B, it is possible to eliminate the waste caused by picking up and returning the scanner during the scanning process. The expected streamlining of assembly processes at individual stations where scanning is used is shown in the updated Yamazumi charts (Figure 10).

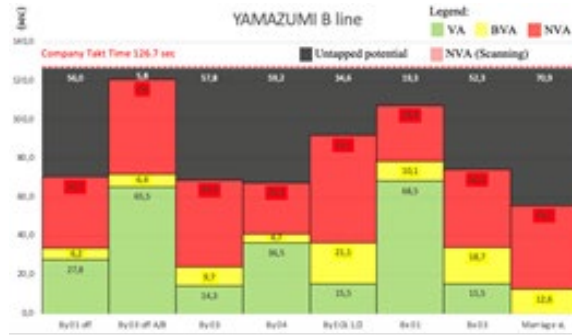

Figure 10

Yamazumi chart after implementation of a new scanning technology

Figure 11 shows the current layout of a selected part of the B_y line, stations B_y 03, B_y 04 off, and B_y 04. At stations B_y 03 and B_y 04, we used the Yamazumi graph (Figure 6) to identify high wastes caused by waiting:

- B_y 03 – 57,8 seconds,
- B_y 04 – 59,2 seconds per operator.

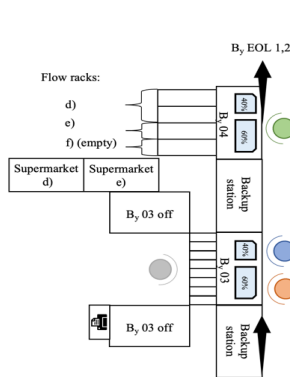

Figure 11

Current layout of the selected part selected of the B line – station B_y 03 and B_y 04

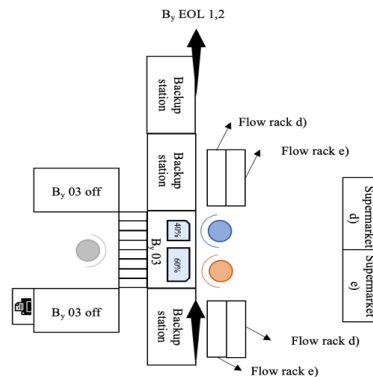

Figure 12

Proposed layout of the selected part of the B line – station B_y 03 and B_y 04

Figure 12 shows the new proposed layout, which was designed based on rebalancing the original one (Figure 11). By moving the flow racks, which are necessary for assembly, and relocating the supermarkets to the other side of the

assembly line so that they are in direct access to the flow racks, it is possible to merge the B_y 03 station with the B_y 04 station. The Yamazumi graphs (Figures 13 and 14) represent the time required to perform all station assembly processes with relation to the CTT before and after the optimization design. With the new layout proposal, it is possible to increase the percentage utilization of B_y 03 station operators from the original 54,38% to 81,14% and at the same time reduce the required number of Line B employees by one operator.

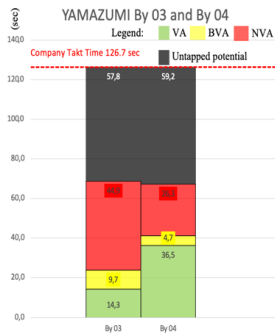

Figure 13

Yamazumi graph before proposal on station By 03 and By 04

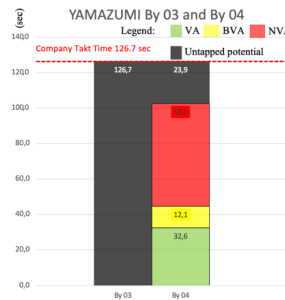

Figure 14

Yamazumi graph after proposal on station By 03 and By 04

Based on the analysis using the spaghetti diagram (Figure 7), we identified waste caused by excessive motion. By interpreting the data using the Yamazumi graph (Figure 10), we identified the waste caused by waiting at stations:

- B_x 01 – 19,3 seconds,
- B_y EOL 1/2 – 35,6 seconds,
- B_x 03 – 52,3 seconds,
- Marriage station – 70,9 seconds

Based on these findings, we can streamline assembly stations by changing the layout and balancing assembly processes between stations. We suggest changing the layout according to Figure 15.

Most important step is to move the B_x assembly line closer to the Marriage station, and therefore also to the B_x rack. This layout change, can reduce the excessive motion of the B_x 03 station operator when inserting the product into the rack by 3,6 seconds. By relocating the B_x assembly line, a new free space will be created behind the line. This space can be used to create a new supermarket zone that would be at a more acceptable distance from the B_y EOL 1/2 stations. By relocating supermarkets, we can reduce the waste caused by the motion of B_y EOL 1/2 station operators by an average of 3,4 seconds.

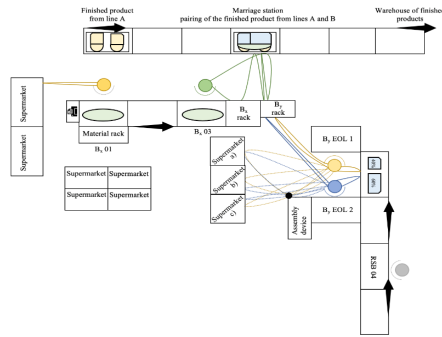

Figure 15

Proposed layout of the selected part of the B line supplemented by a spaghetti diagram

Due to high waste of waiting, it is possible to rebalance the assembly processes between the stations B_x 01, B_x 03, and Marriage station by moving selected parts of the assembly process activities of the B_x 03 station (in the duration of 7,9 sec of a total 13,7 sec) to the B_x 01 station. The next balancing step is to remove the Marriage station operator and move all his assembly processes out to the B_x 03 station.

Yamazumi graphs (Figures 16 and 17) represent the outcome of process rebalancing even though the graphs also take into account the streamlining of the scanning process by implementing the new Industry 4.0 technology.

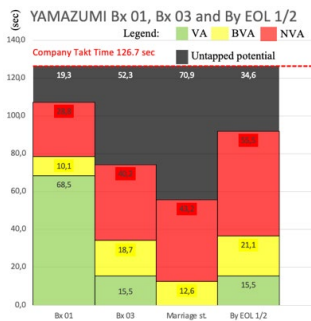

Figure 16

Yamazumi graph before proposal on station Bx 01, Bx 03, Marriage station and By EOL 1/2 and By 04.

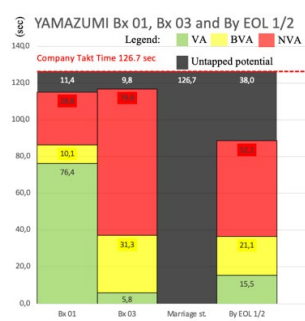

Figure 17

Yamazumi graph proposal on station Bx 01, Bx 03, Marriage station and By EOL 1/2 and By 04

The utilization of operators on the B_x line would increase after balancing. The utilization of the operator of B_x 01 station would change from the original 84,77% to 91% and of the B_x 03 station from 58,72% to 92,27%. The utilization of the operators of the B_y EOL 1/2 station would decrease from 72,69% to 71,01% due to the streamlining of the layout and the reduction of motion waste.

By implementing the proposal, we would be able to remove the operator of the Marriage station.

As a result of Value Stream Mapping (Figure 5), we identified waste of overproduction. Work in progress (WIP) is located on the racks for finished products of the B_x and B_y lines. The minimum stock (3 pcs defined as a standard of organization) is necessary in case of errors in the assembly process. However, there is a maximum stock of 3 pcs in the rack of B_x products and maximum stock of up to 8 pcs in the rack of B_y line products, which creates a disparity between them. The creation of excess stock is caused by different assembly times of the assembly lines: A – 27,45 minutes, B_x – 6,34 minutes, B_y – 14,78 minutes.

The reduction of stocks in the B_x rack is ensured by changing the BT printing (orders). BT is not printed at station B_x 01 at the time of receipt of orders, but only after scanning BT at station A 14. This change provides space to assemble the required product (B_x) only when it's needed due to shorter line assembly time. It also contributes to reducing work in progress.

BT is printed at the moment of receiving the order on the B_y line (B_y 1 off). The same reference of the main product is mounted in parallel on line A and line B_y in spite of different assembly times of the lines. By proposing to use the same principle of BT printing on the B_y line, and B_x line, it would be possible to reduce WIP. Whereas there is a longer time of B_y line compared to B_x line, authors of the paper propose to print BT on station B_y 01 off at the moment of scanning BT on station A 07. By proposing a change of BT printing on the RSB line, we would be able to reduce stocks in the B_y racks from 8 pcs. to 3pcs.

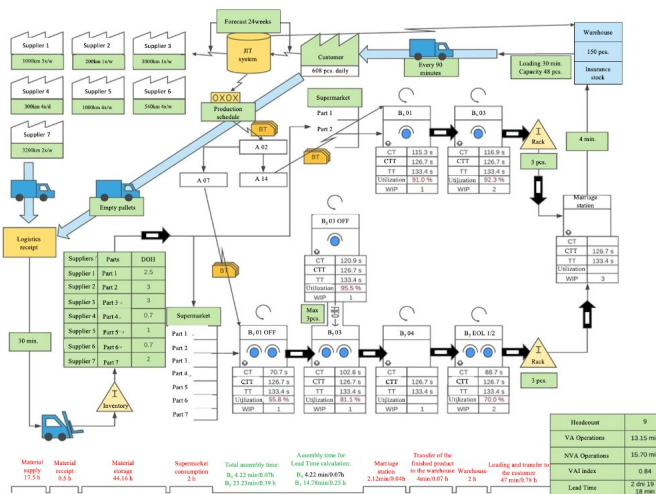

Figure 18
VSM map of B line after implementing proposals

Figure 18 shows the future Value Stream Map for line B after the implementation of each proposal.

By implementing proposals - balancing assembly stations, changing layouts, and implementing selected Industry 4.0 technologies, the organization would be able to:

- reduce the number of operators on line B from 11 to 9, reduce labor costs,
- reduce the time of VA operations from 16,07 minutes to 13,15 minutes,
- reduce the value of the VAI index from 1,02 to 0,84,
- eliminate identified wastes, streamline assembly processes,
- improve the ergonomic conditions of employees,
- reduce WIP, optimize the percentage utilization of operators.

Conclusion

The link between Lean production and Industry 4.0 implementation can be identified at a glance. Lean production is considered an important building block of digitalization of organisations. Comparing obtained mean values of lean production utilisation with results of surveys using same scale and instrument for examining management tools utilisation, reveals that lean production is not amongtop ten used management tools in Central Europe, implying a relative low readiness for Industry 4.0 implementation [34]. It is necessary to realize that the implementation of lean manufacturing as well as the principles and methods of Industry 4.0 into business is a strategic decision of the company's top management. Based on the findings, it is possible to declare that Industry 4.0 technologies and Lean Manufacturing methods can be integrated. This integration can multiply the effect of their use - streamlining production, improving processes, working conditions and all activities that lead to a leaner production.

Acknowledgement

The paper is a part of project VEGA No. 1/0721/20 „*Identification of priorities for sustainable human resources management with respect to disadvantaged employees in the context of Industry 4.0*“.

This publication has been published with the support of the Operational Program Integrated Infrastructure within project “*Research in the SANET network and possibilities of its further use and development*”, code ITMS 313011W988, co-financed by the ERDF.

References

- [1] Pavlovic, D., Milosavljevic, P., Miladenovic, S.: Synergy between Industry 4.0 and lean methodology. *J. Mechatron. Autom. Identif. Technol.* 5(4), 17-20 (2020)

- [2] Valamede, L. S., Akkari, A. C. S., & Cristina, A. (2020) Lean 4.0: A new holistic approach for the integration of lean manufacturing tools and digital technologies. *International Journal of Mathematical, Engineering and Management Sciences*, 5(5), 851-868, <https://doi.org/10.33889/IJMEMS.2020.5.5.066>
- [3] Czifra, G., Szabó, P., Míkva, M., & Vaňová, J. (2019) Lean principles application in the automotive industry. *Acta Polytechnica Hungarica*, 16(5), 43-62. DOI: 10.12700/APH.16.5.2019.5.3
- [4] Johanesová, V., Stupavská, L., Vanova, J., & Cambal, M. (2019) Linking Industry 4.0 and Slovak Republic. *DAAAM Proceedings; Katalinic, B., Ed.; DAAAM International Vienna: Vienna, Austria, 1*, 1122-1130
- [5] Azemi, F., Šimunović, G., Lujčić, R., Tokody, D., & Rajnai, Z. (2019) The use of advanced manufacturing technology to reduce product cost. *Acta Polytechnica Hungarica*, 16(7), 115-131, DOI: 10.12700/APH.16.7.2019.7.7
- [6] The path from Industry 4.0 to Industry 5.0 [online] [cit. 2023-11-03] Available on: <https://www.atoss.com/en/insights/blog/from-industry-4-0-to-industry-5-0>
- [7] Cabrita, M. D. R., Domingues, J. P., & Requeijo, J. (2016) Application of Lean Six-Sigma methodology to reducing production costs: case study of a Portuguese bolts manufacturer. *International Journal of Management Science and Engineering Management*, 11(4), 222-230, <https://doi.org/10.1080/17509653.2015.1094755>
- [8] Sarkar, B., & Moon, I. (2014) Improved quality, setup cost reduction, and variable backorder costs in an imperfect production process. *International journal of production economics*, 155, 204-213, <https://doi.org/10.1016/j.ijpe.2013.11.014>
- [9] Ouyang, L. Y., Chen, C. K., & Chang, H. C. (2002) Quality improvement, setup cost and lead-time reductions in lot size reorder point models with an imperfect production process. *Computers & Operations Research*, 29(12), 1701-1717, [https://doi.org/10.1016/S0305-0548\(01\)00051-X](https://doi.org/10.1016/S0305-0548(01)00051-X)
- [10] Dey, S., Sharma, R. R. K., & Pandey, B. K. (2019) Relationship of manufacturing flexibility with organizational strategy. *Global Journal of Flexible Systems Management*, 20(3), 237-256, <https://doi.org/10.1007%2Fs40171-019-00212-x>
- [11] Santosa, W. A., & Sugarindra, M. (2018) Implementation of lean manufacturing to reduce waste in production line with value stream mapping approach and Kaizen in division sanding upright piano, case study in: PT. X. In *MATEC Web of Conferences* (Vol. 154, p. 01095) EDP Sciences. <https://doi.org/10.1051/matecconf/201815401095>

- [12] Buer, S. V., Strandhagen, J. O., & Chan, F. T. (2018) The link between Industry 4.0 and lean manufacturing: mapping current research and establishing a research agenda. *International journal of production research*, 56(8), 2924-2940
- [13] Křivánek, D. (2009) *The way to lean*. (Guide to obstacles and rules) Žilina: IPA Slovakia
- [14] Mašín, I. (2003) *Value stream mapping in production processes*. 1st Edition. Liberec: Institute of Industrial Engineering. ISBN 80-902235-9-1
- [15] Capital, M. (2004) Introduction to lean manufacturing for Vietnam. Published Article by Mekong Capital Ltd.
- [16] Elnamrouty, K., & Abushaaban, M. S. (2013) Seven wastes elimination targeted by lean manufacturing case study “gaza strip manufacturing firms”. *International Journal of Economics, Finance and Management Sciences*, Vol. 1, No. 2, 2013, pp. 68-80, doi: 10.11648/j.ijefm.20130102.12
- [17] Shah, D., & Patel, P. (2018) Productivity improvement by implementing lean manufacturing tools in manufacturing industry. *International Research Journal of Engineering and Technology*, 5(3), 3-7
- [18] The 8 Wasted of Lean [online] [cit. 2021-08-20] Available on: <https://theleanway.net/The-8-Wastes-of-Lean>
- [19] Manyika, J., Chui, M., Bisson, P., Woetzel, J., Dobbs, R., Bughin, J., & Aharon, D. (2015) *The Internet of Things: Mapping the value beyond the hype*. Publisher: Mckinsey Global Institute
- [20] Pyzdek, T. (2021) Spaghetti Diagrams. In *The Lean Healthcare Handbook* (pp. 25-28) Springer, Cham. [online] [cit. 2021-08-20] Available on: <https://link.springer.com/content/pdf/10.1007%2F978-3-030-69901-7.pdf>
- [21] Spaghetti chart [online] [cit. 2021-09-25] Available on: <https://www.lean.org/lexicon/spaghetti-chart>
- [22] Senderská, K., Mareš, A., & Václav, Š. (2017) Spaghetti diagram application for workers’ movement analysis. *UPB Scientific Bulletin, Series D: Mechanical Engineering*, 79(1), 139-150, https://www.scientificbulletin.upb.ro/rev_docs_arhiva/full5a2_608068.pdf
- [23] All About Spaghetti Diagrams [online] [cit. 2021-09-25] Available on: <https://www.allaboutlean.com/spaghetti-diagrams/>
- [24] Abdulmalek, F. A.; Rajgopal, J. (2007) Analyzing the benefits of lean manufacturing and value stream mapping via simulation: A process sector case study. *International Journal of production economics*, 2007, 107.1: 223-236, <https://doi.org/10.1016/j.ijpe.2006.09.009>

- [25] What is Value Stream mapping? Benefits and Implementation [online] [cit. 2021-09-25] Available on: <https://kanbanize.com/lean-management/value-waste/value-stream-mapping>
- [16] Value Stream Mapping (VSM) [online] [cit. 2021-09-25] Available on: <https://www.creativesafetysupply.com/articles/value-stream-mapping-vsm/>
- [27] Fekete, M. & Hulvej, J. (2013) „Humanizing“ Takt Time and Productivity in the Labor – Intensive Manufacturing Systems [online]. Zadar, Croatia – *International Conference 2013* [cit. 2018-05-16] ISBN 978-961-6914-02-4. Dostupné na internete: <http://www.toknowpress.net/ISBN/978-961-6914-02-4/papers/ML13-245.pdf>
- [28] Mayr, A., Weigelt, M., Kühn, A., Grimm, S., Erll, A., Potzel, M., & Franke, J. (2018) Lean 4.0-A conceptual conjunction of lean management and Industry 4.0. *Procedia Cirp*, 72, 622-628, <https://doi.org/10.1016/j.procir.2018.03.292>
- [29] Santos, D. M. C., Santos, B. K., & Santos, C. G. (2021) Implementation of a standard work routine using Lean Manufacturing tools: A case Study. *Gestão & Produção*, 28(1), e4823, <https://doi.org/10.1590/0104-530X4823-20>
- [30] Semjon V. & Evin E., (2009) Increasing the productivity of the assembly line by balancing of assembly stations using the Yamazumi method. *Transfer Inovácií* 13, 2009, 73-77
- [31] Sabadka, D., Molnár, V., Fedorko, G., & Jachowicz, T. (2017) Optimization of production processes using the Yamazumi method. *Advances in Science and Technology. Research Journal*, 11(4), 175-182, DOI: <https://doi.org/10.12913/22998624/80921>
- [32] ZEBRA wireless scanner [online] [cit. 2021-05-25] Available on: www.zebra.com, 2020
- [33] Gloves MARK 2 standard [online] [cit. 2021-05-25] Available on: www.proglove.com, 2020
- [34] Rashad, W., Lazanyi, K., Potocan, V., & Nedelko, Z. (2019) How does Business Orientation of Manufacturing Enterprises Define the Utilisation of Lean Production. *Acta Polytech. Hung*, 17, 257-276, DOI: 10.12700/APH.17.9.2020.9.1